

IF USING A PLASTIC PROP, USE A 6" PROP OR A 7" PROP CUT DOWN TO 6". SHAVE TO LIGHTEN.

STAB IS 1/16" SQUARE THAT IS WET FORMED TO SHAPE. COVER UPPER SURFACE ONLY.

NOSE IS BLACK ON WHITE CHECK PATTERN AS SHOWN.

COVER LEFT SIDE OF MODEL ONLY.

WET FORM ALL CURVED OUTLINES.

WHITE INSIDE THESE AREAS

WHITE LETTERS

FUSELAGE IS 1/16" SQUARE

WHITE STRIP WITH BLACK EDGES.

INSERT THIS SPACER AFTER STAB IS PLACED IN THE SLOT. REPLACE COVERING WHERE SLOT IS EMPTY.

WHITE LETTERING

MOTOR STICK

WHITE STRIP

LIGHT GRAY BELOW THIS LINE.



P-47D-25
FAC NO-CAL SCALE
 DESIGNED AND DRAWN
 BY PAUL BRADLEY
 12/93

SHEET 1 OF 3 FROM INTERNET DOWNLOAD

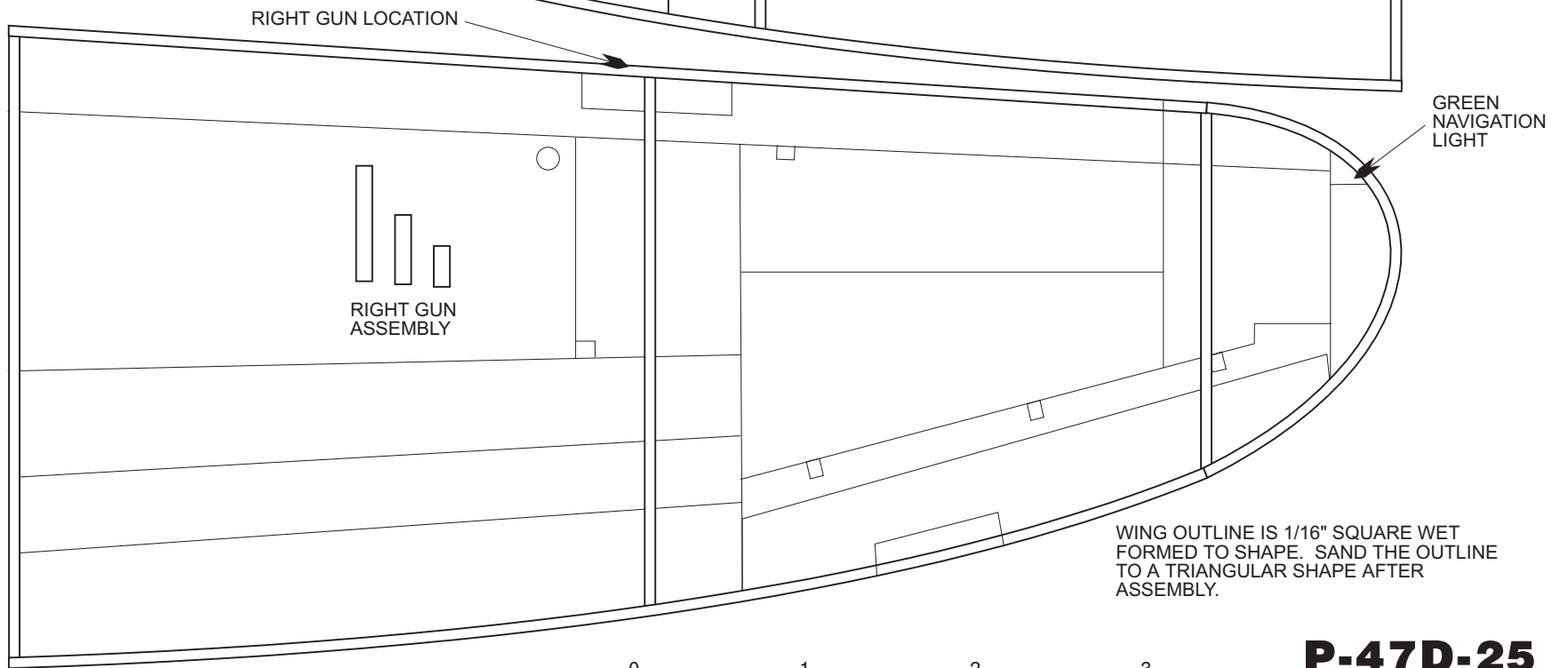
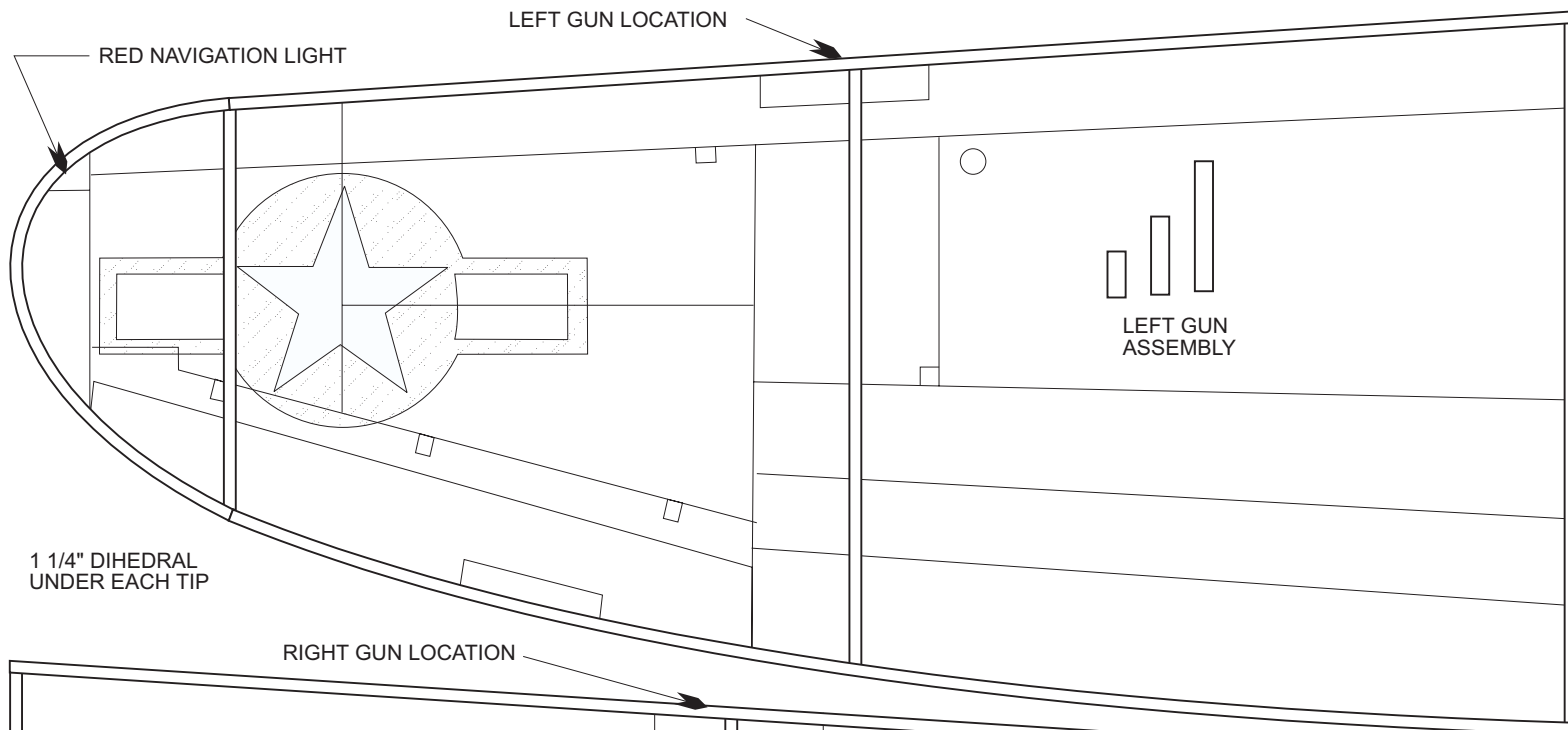

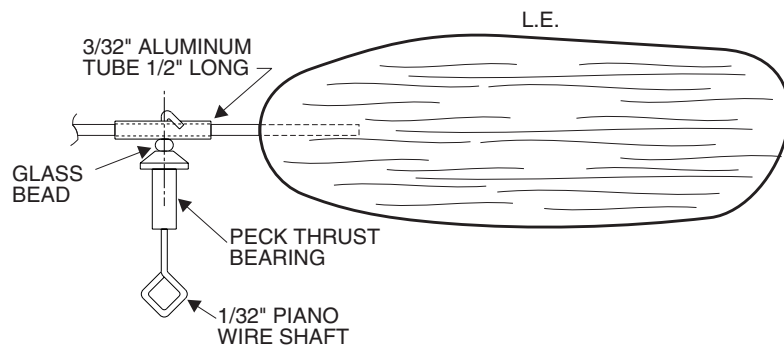

PROP BLADES ARE 1/32" SHEET FORMED ON A 3" CYLINDER. SET EACH BLADE WITH THE LEADING EDGE 15 DEGREES LEFT FROM VERTICAL ON THE CYLINDER. MAKE 2 IDENTICAL BLADES FOR THE PROP ASSEMBLY. PROP SPARS ARE MADE FROM BAMBOO ROUNDED TO 1/16" DIAMETER. A GOOD SOURCE FOR BAMBOO IS SHISH KABOB SKEWERS. GLUE THE SPARS INTO THE ALUMINUM TUBE. USE REGULAR MODEL AIRPLANE CEMENT FOR THIS SO PITCH ADJUSTMENTS CAN BE MADE BY SOFTENING THE GLUE WITH ACETONE.

COLORING

OVERALL COLOR IS MEDIUM GREEN WITH BLACK AND WHITE STRIPS AND LIGHT GRAY UNDERSIDE AS NOTED. NATIONAL INSIGNIA IS WHITE ON A DARK BLUE SURROUND.

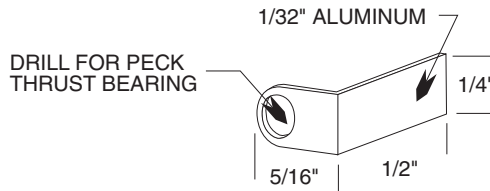

PROP HANGER DETAIL

REAR HOOK IS .020 WIRE INSERTED THROUGH THE Balsa TUBE AND BLOCK INSERT. MAKE AN "L" BEND AND ATTACH WITH CA.

1/8" X 1/2" BLOCK INSERTED IN EACH END OF THE ROLLED TUBE.

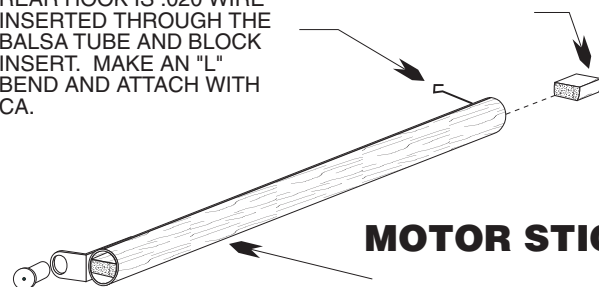

MOTOR STICK

MOTOR STICK IS A ROLLED 1/32" Balsa TUBE 9 1/2" LONG FORMED ON A 1/4" DOWEL. IT IS GLUED TO THE RIGHT SIDE OF THE FUSELAGE STRUCTURE AFTER THE STRUCTURE IS COVERED.

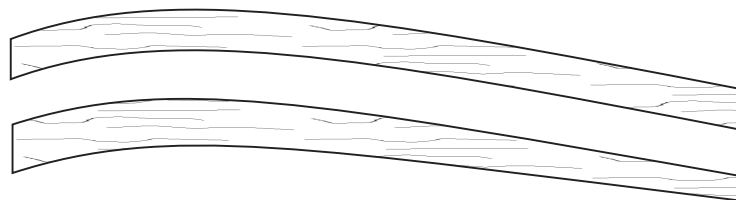
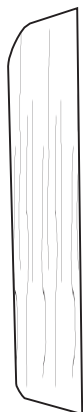

ALL PARTS ARE CUT FROM 1/16" SHEET Balsa



CUT WING RIBS FROM 1/16" SHEET. TRIM TO LENGTH FROM TRAILING EDGE.



P-47D-25
FAC NO-CAL SCALE
DESIGNED AND DRAWN
BY PAUL BRADLEY
12/93