

SIDE VIEW

FIRST STEP

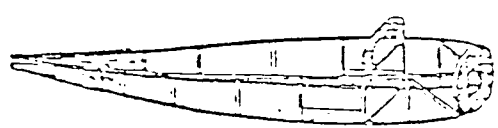

SECOND STEP

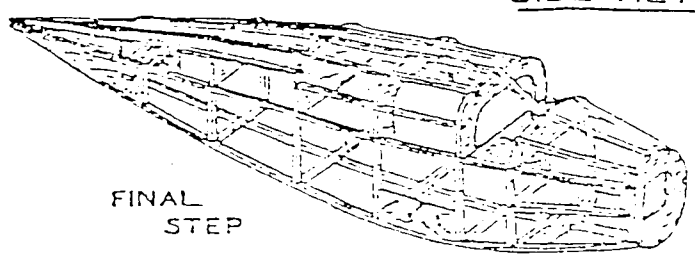

FINAL STEP

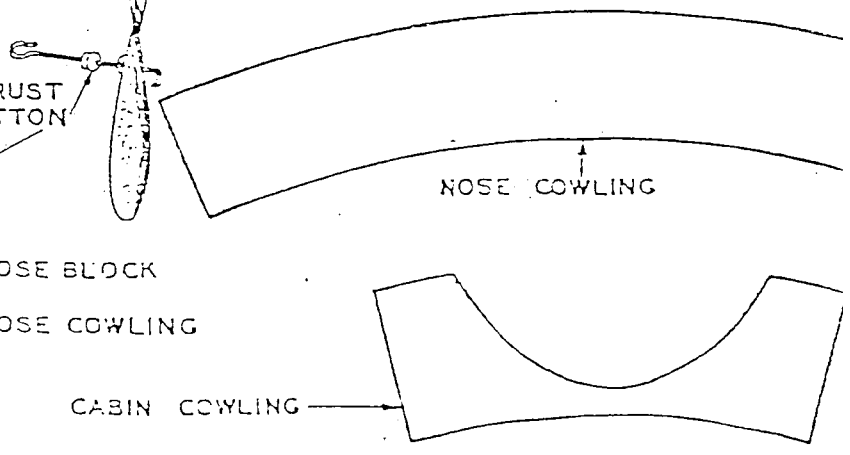
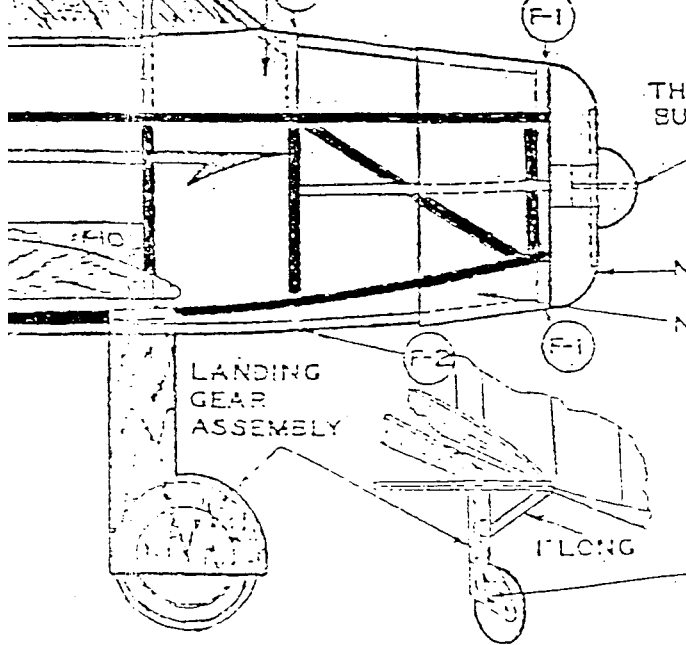
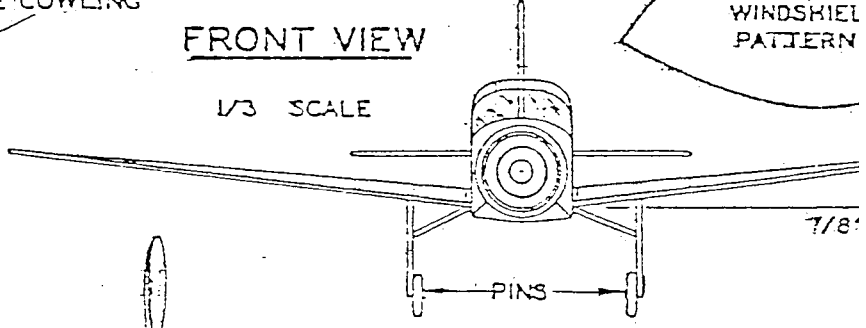
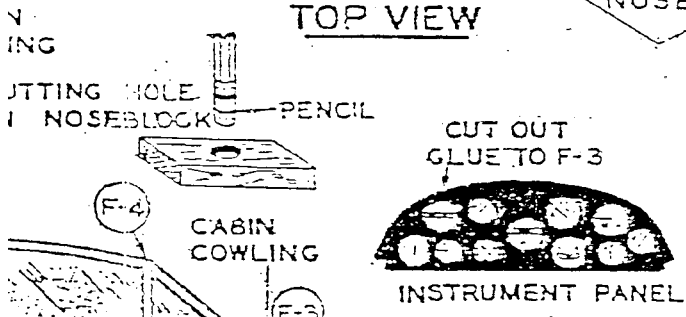
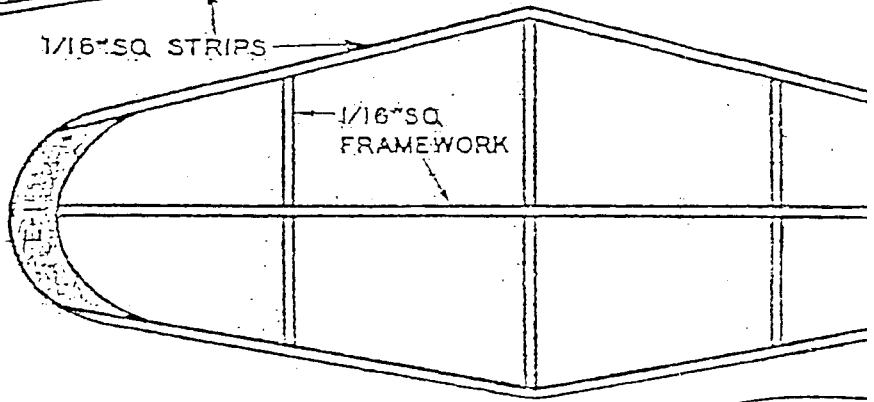
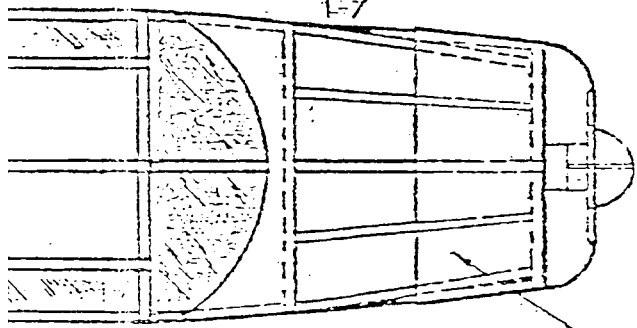
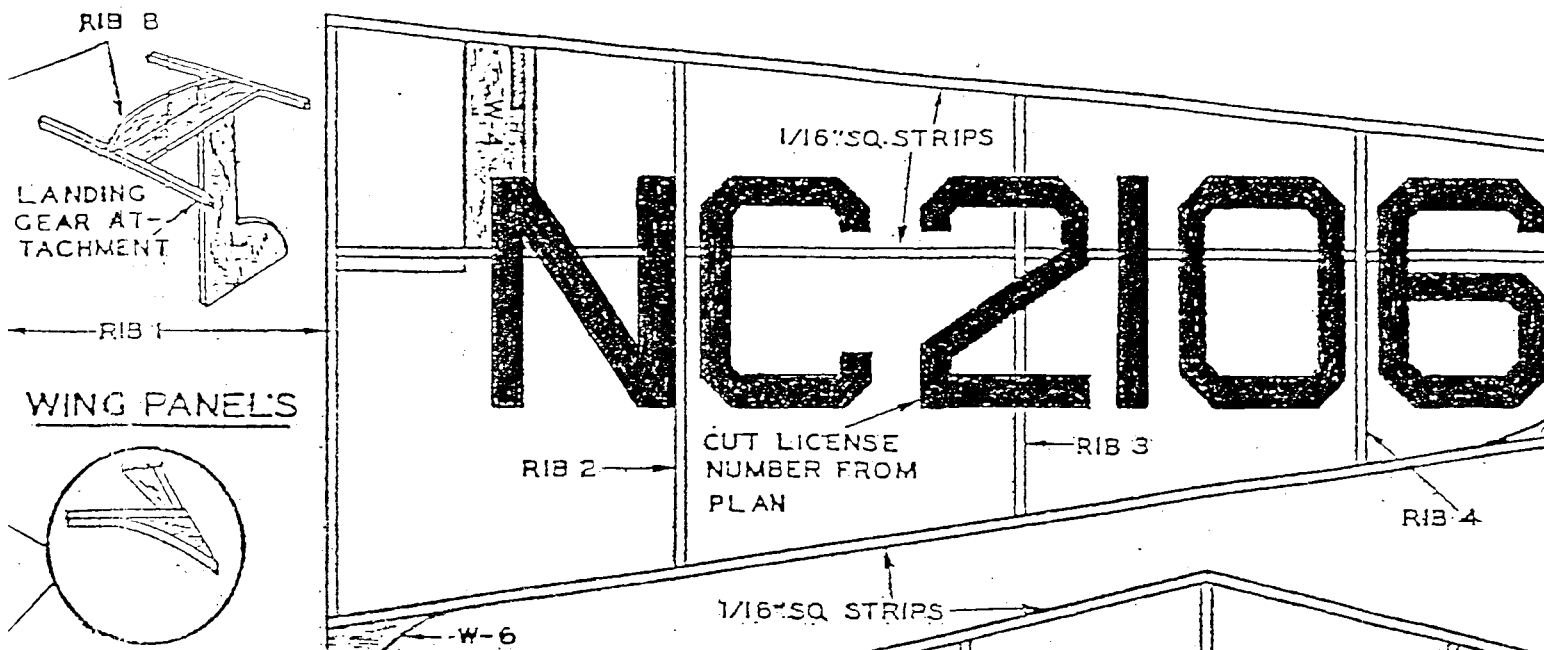

HARLOW
 WINGSPAN 16" | LE
 DRAWN BY [Signature] | K

WING LIGHT

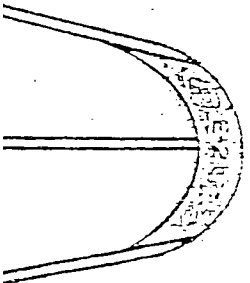
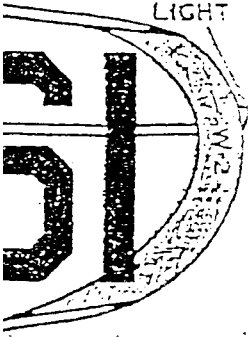

SHIELD FERN

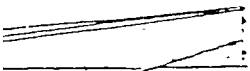

7/8° DIHEDRAL

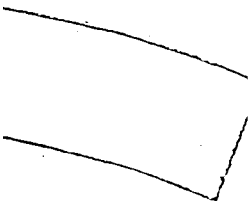

HARLOW

OW

LENGTH 12"

KIT NO. A2

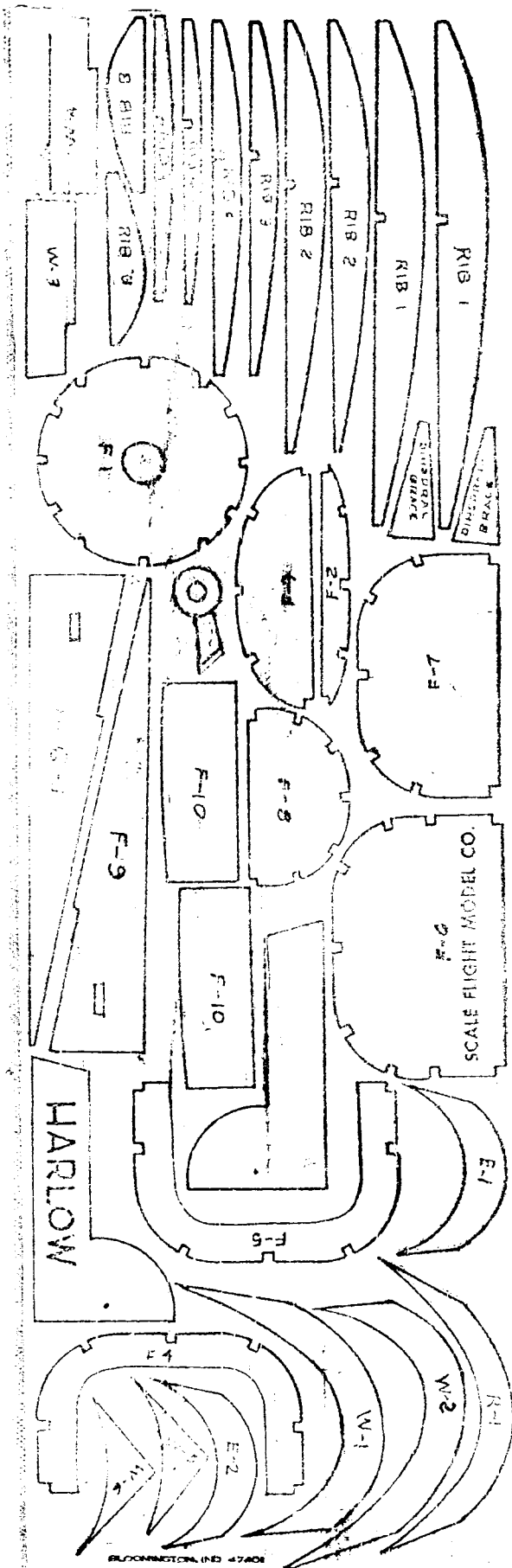

BLOOMINGTON, IN 47401